

	WLW 25MM WORKTOP	Scale : 1.235
12/06/09	Box 052	

SET UP AS 25MM W-TOP RUN
OUTSIDE STAY 34MM THICK

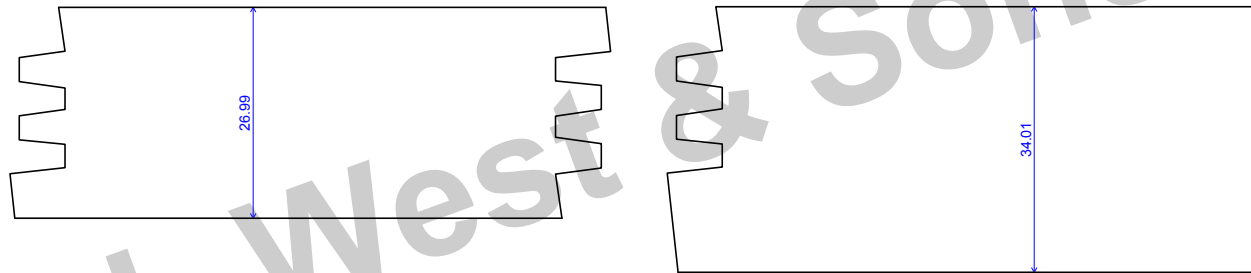

© W.L. West & Sons Ltd

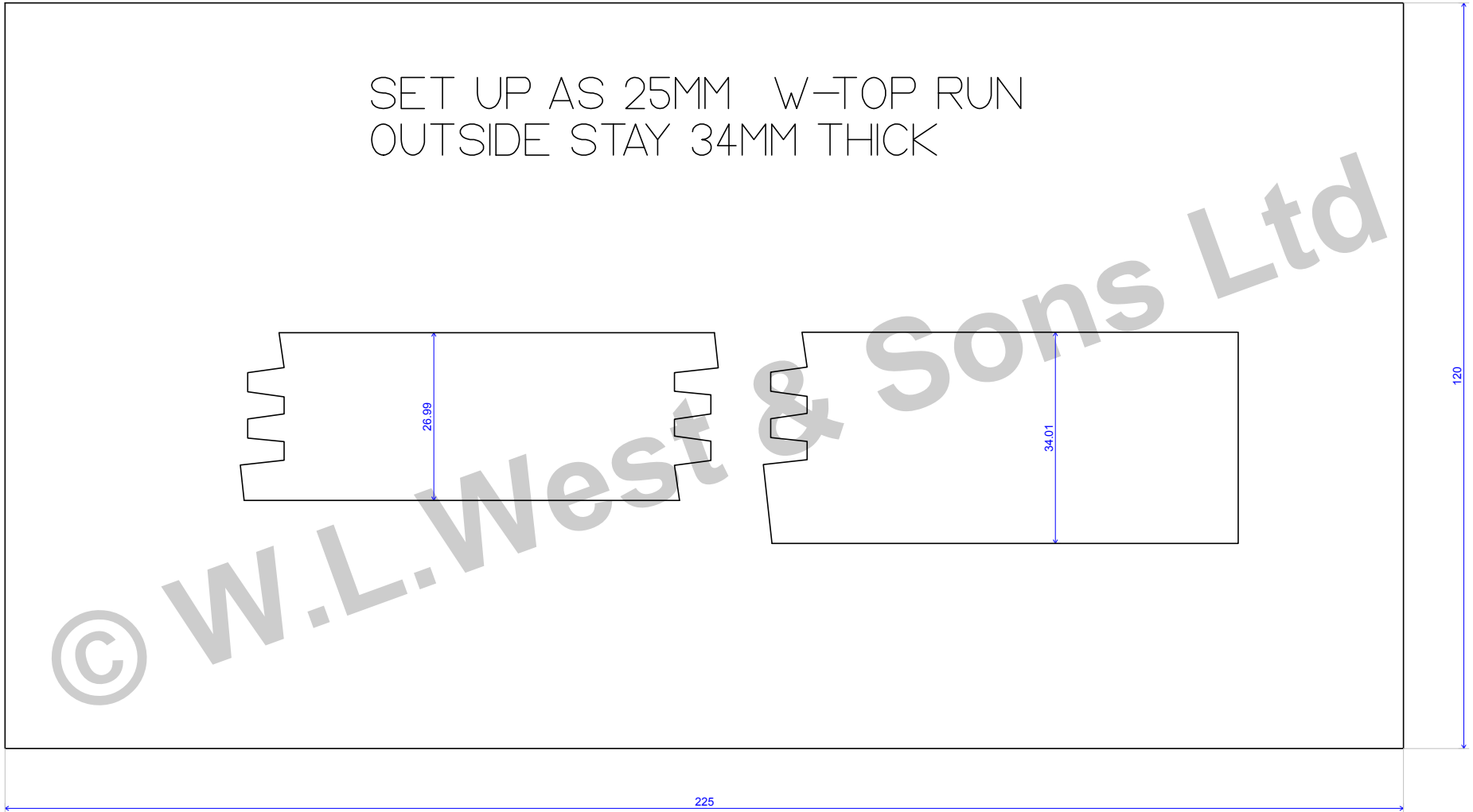

	WLW 25MM WITH 32MM FRONT STAVE	Scale : 1.034
12/06/09	Box 056	

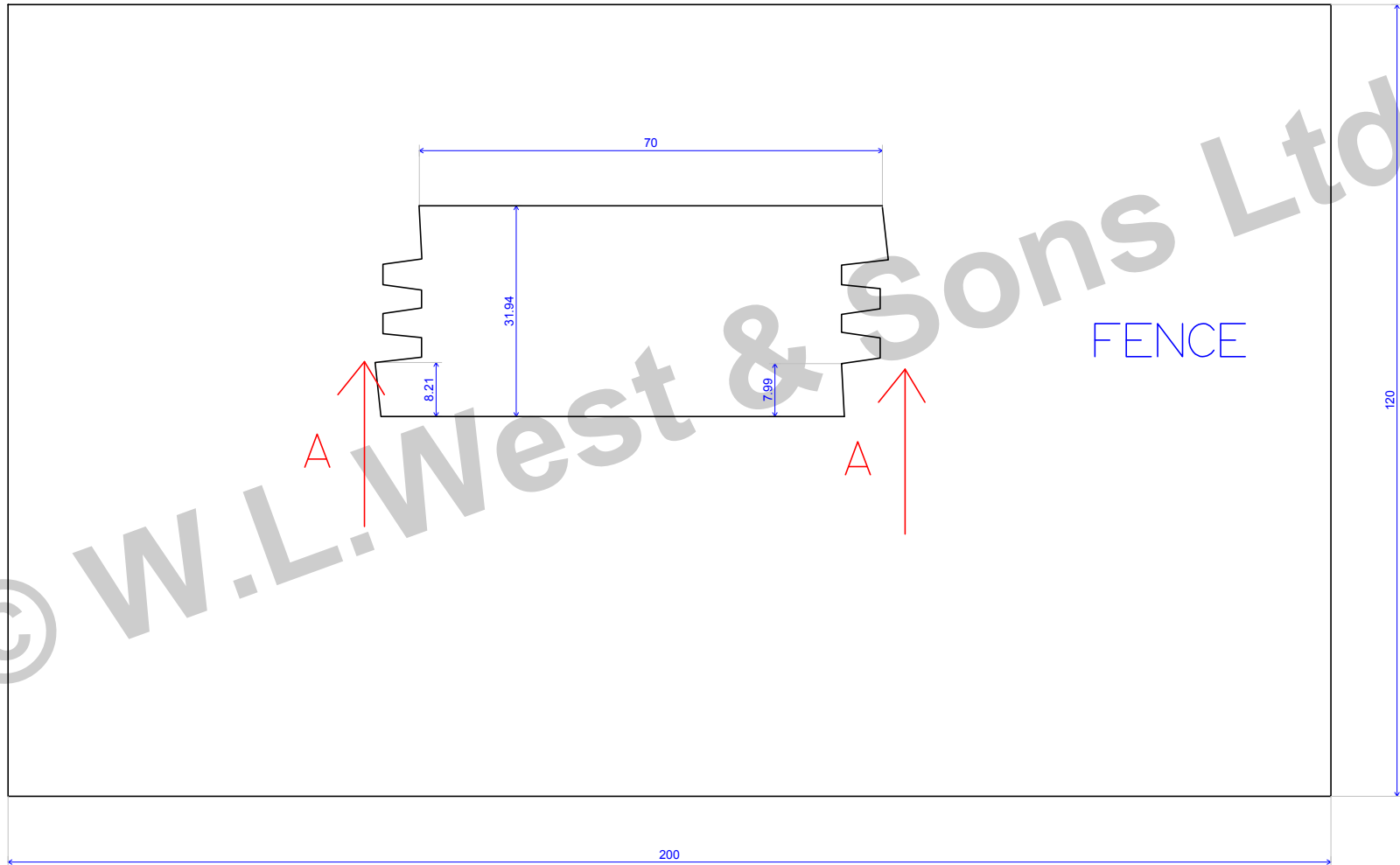

		
	WLW 30MM WORKTOP	Scale : 1
12/06/09	Box 051	

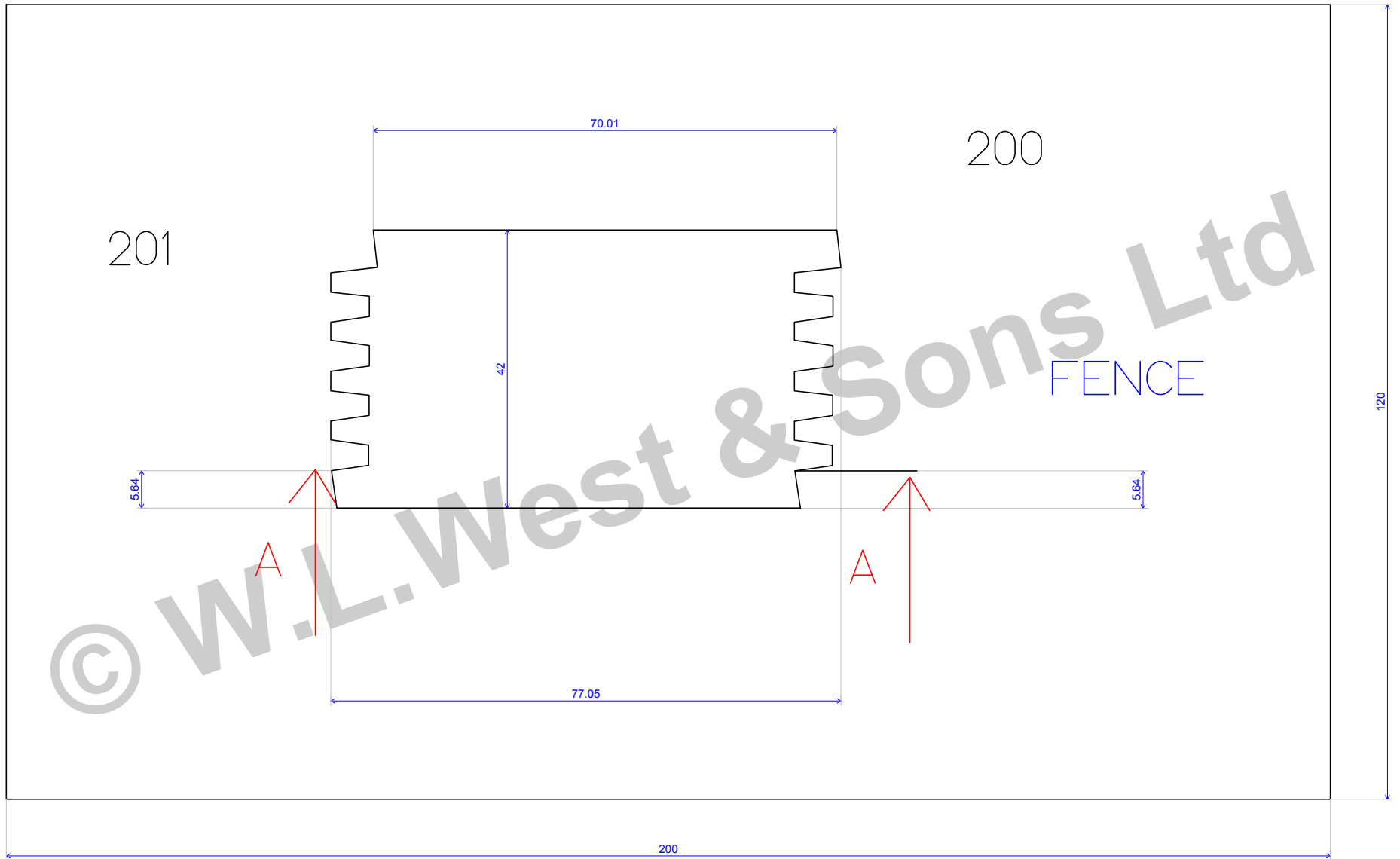

	WLW 40MM WORKTOP	Scale : 1.164
12/06/09	Box 050	

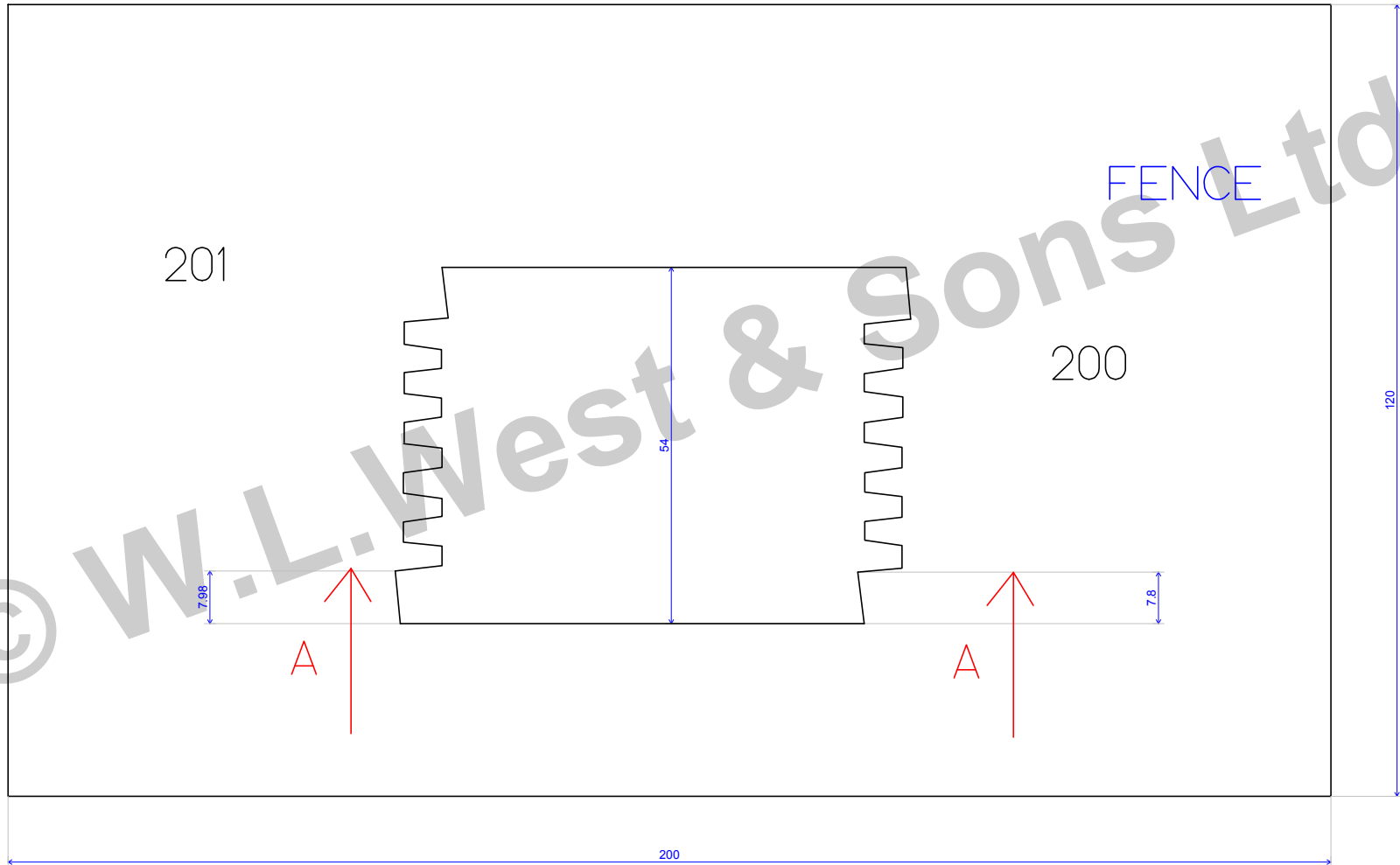

	WLW 52MM WORKTOP	Scale : 1
12/06/09	Box 061	

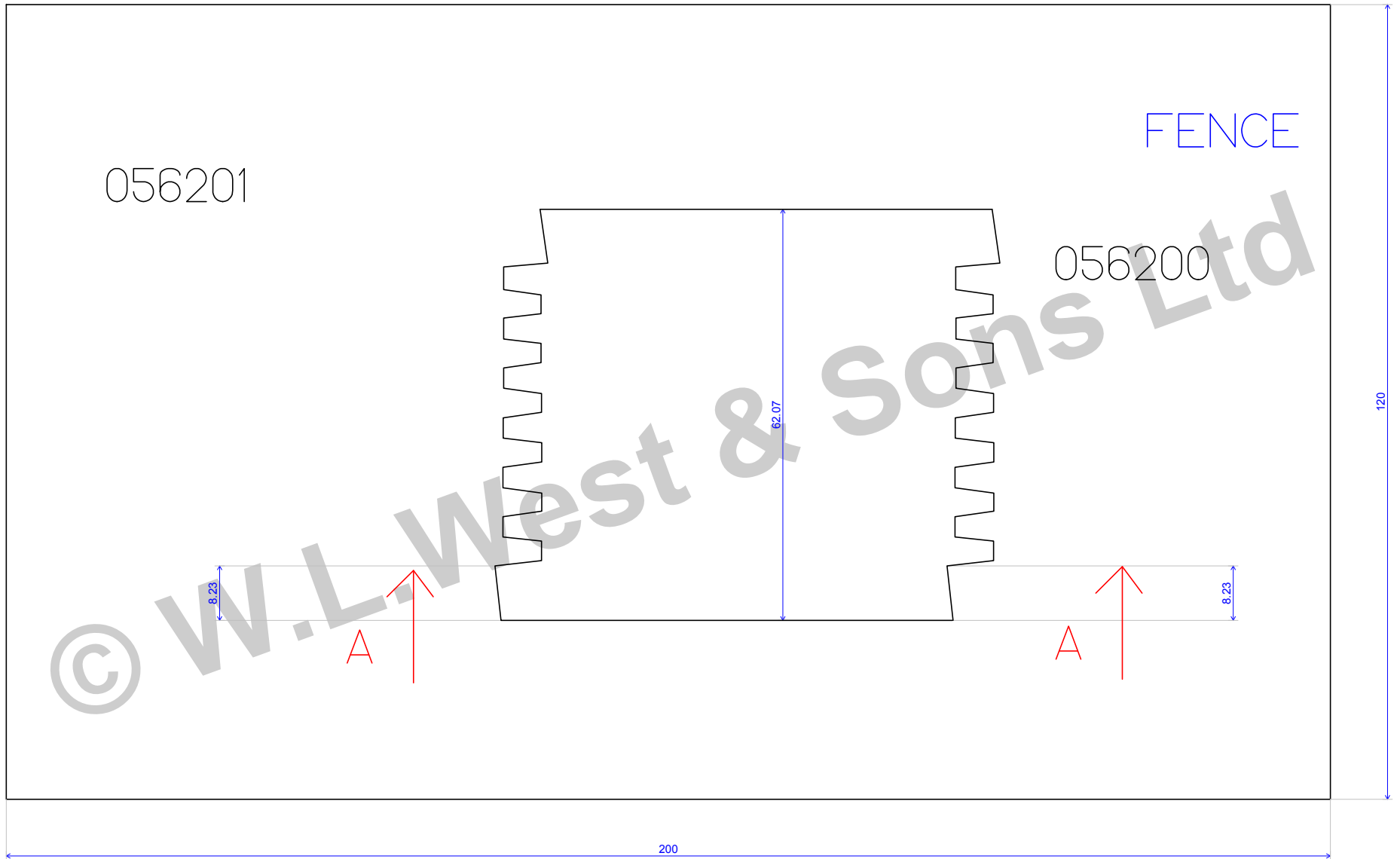

	WLW 60MM WORKTOP	Scale : 1.164
12/06/09	Box 056	

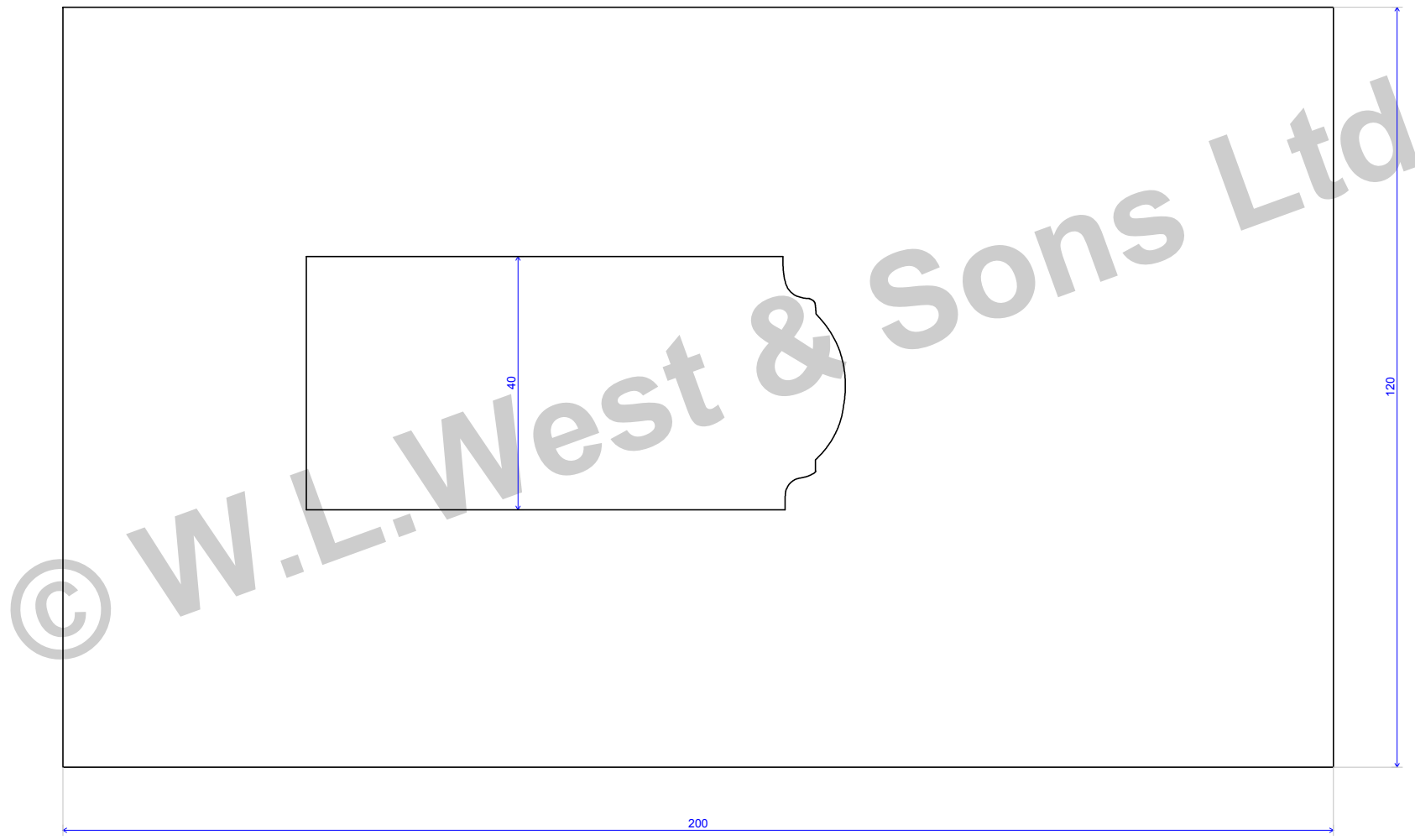

	WLW EDGE PROFILE	Scale : 1
11/06/09	Routed Edge	

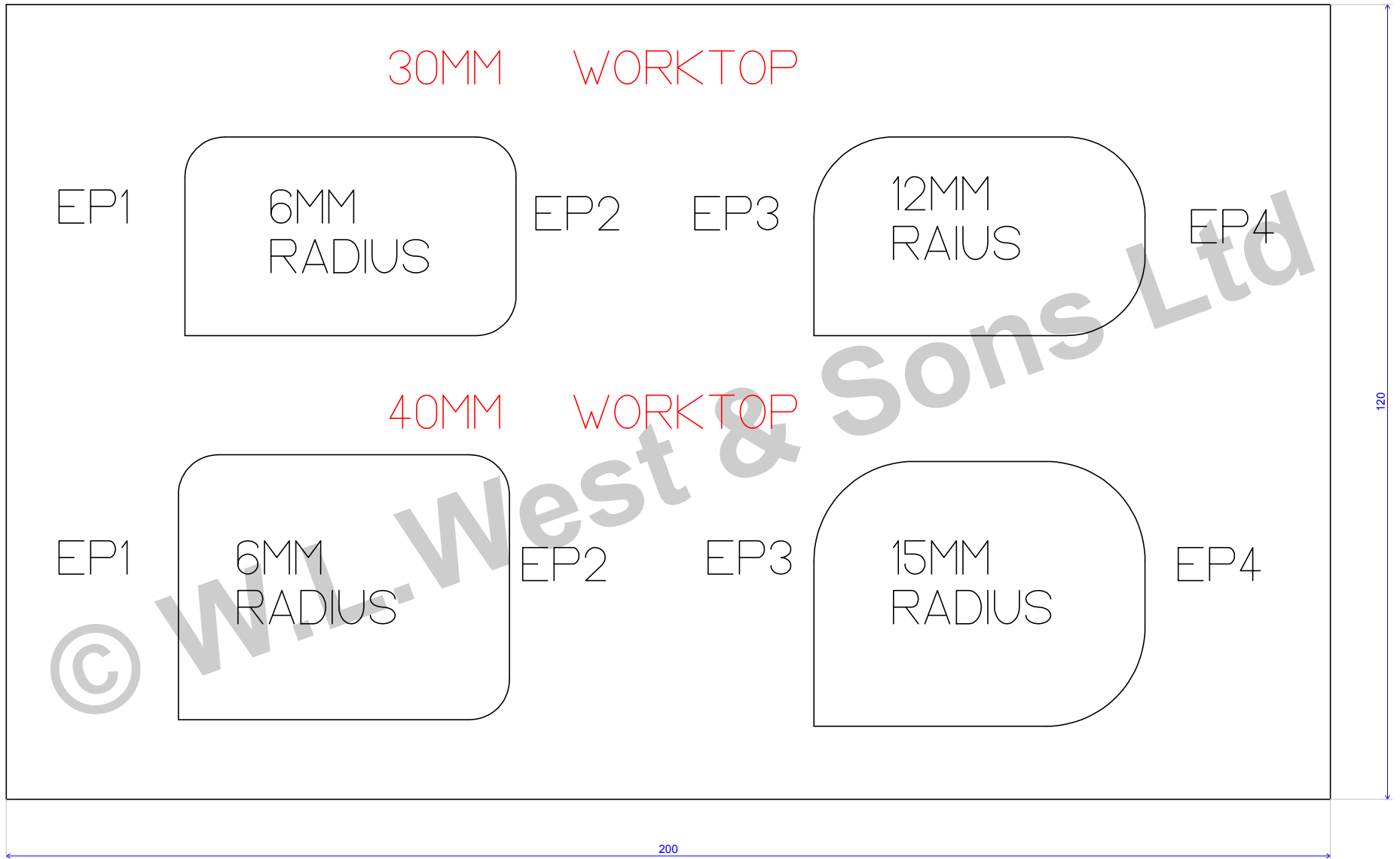

© W.L. West & Sons Ltd

	WLW W TOP RADIUS 30MM/40MM	Scale : 1.164
11/06/09		